



Festoon System

Mobile Electrification System

Catalogue

C-track, I-beam, Wire-rope Series



NANTE cable festoon system provide a safe, effective and economical way of supplying power to cranes, hoists and moving machinery travelling along fixed tracks. NANTE can offer the festoon system for C track, I beam, Angel Bar, Wire rope, Square Pipe etc.

Features:

- Safe and reliable
- Simple to install or modify
- Enclosed self cleaning track
- Minimum maintenance

General

1. C-track
2. Joint
3. Hanger
4. End Stop
5. End Cap
6. Towing Trolley
7. Middle Trolley
8. End Trolley
9. Support Bracket
10. Cable
11. Steel Wire

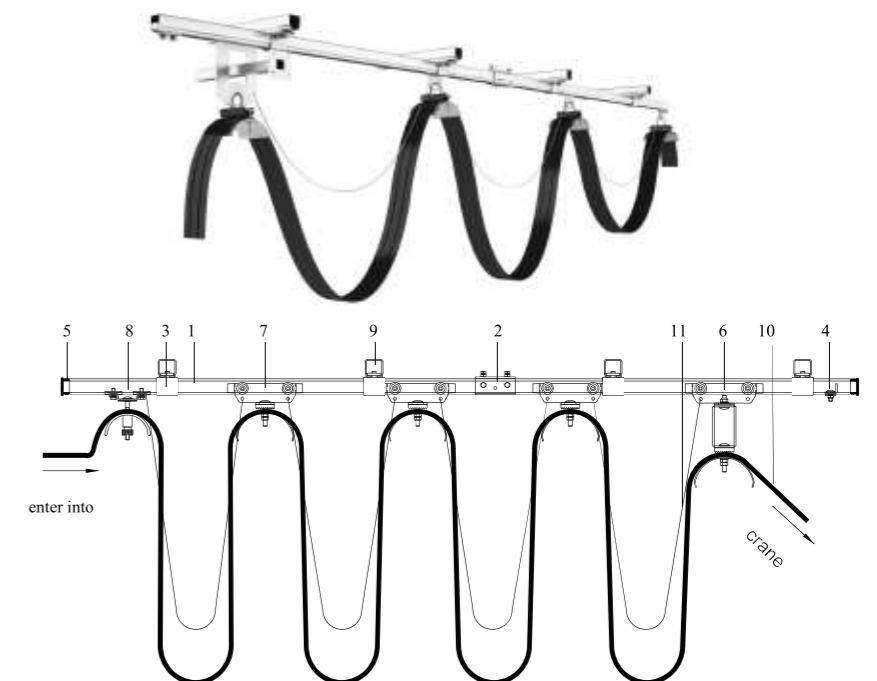

Technical Data

Travel speed	< 120m/min
Temperature	-40°C -- +125°C
Cable load	< 120kg

Travel speed	Cable loop depth
max.35m/min	≥0.3m
35-50m/min	≤0.8m
50-80m/min	≥0.8m

C-track Festoon accessories - C-track
C32/ C40/ C63

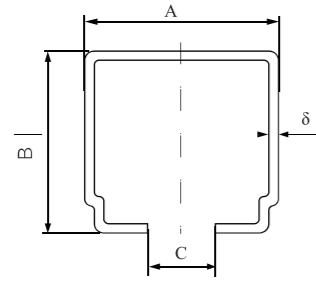

$L = n \times \pi R / 180^\circ$
L is curve length,
n is central angle,
R is curved radius

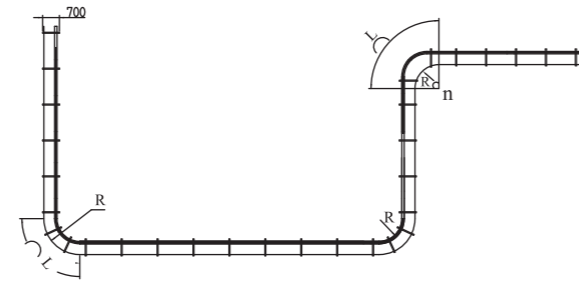

Type	Weight (kg/m)	A	B	C	δ
C32*30*1.5	1.19	32	30	12	1.5
C40*40*2.0	2.0	40	40	13	2.0
C63*63*4.0	5.98	63	63	18	18

Material: Galvanized Steel, 304#, 316# Stainless Steel
(Nylon coating is optional for heavy corrosion environment)
Curve $R \geq 1.0m$, only C32 can be curve



C-track Festoon Accessories - C32 Trolley for Flat Cable
C32TT-75/ C32MT-75

C32TT-75 - Towing trolley

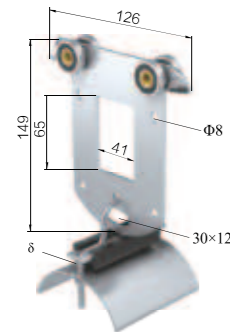

Technical Feature

Wheels: Ball bearing
Max Travel Speed: 160m/min
Material: Galvanized Steel + ABS
Temperature: $-30^\circ\text{C} \sim +100^\circ\text{C}$
Max. Cable (mm): 75 W* 32mm
Max. Cable weight: 25kg
Weight of Trolley: 0.59kg

C32MT-75 - Middle trolley

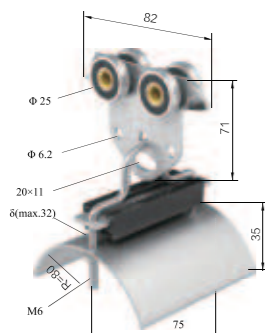

Technical Feature

Wheels: Ball bearing
Max Travel Speed: 160m/min
Material: Galvanized Steel + ABS
Temperature: $-30^\circ\text{C} \sim +100^\circ\text{C}$
Max. Cable (mm): 75 W* 32mm
Max. Cable weight: 30kg
Weight of Trolley: 0.41kg

C-track Festoon Accessories - C32 Trolley for Flat Cable
C32TT-70/ C32MT-70 / C32ET

C32TT-70 - Towing trolley

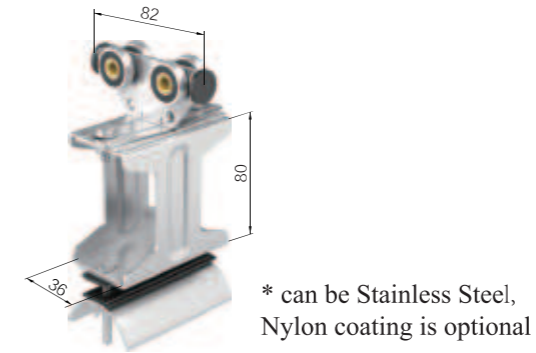

* can be Stainless Steel,
Nylon coating is optional

Technical Feature

Wheels: Ball bearing
Max Travel Speed: 120m/min
Material: Galvanized Steel + ABS
Temperature: $-30^\circ\text{C} \sim +100^\circ\text{C}$
Max. Cable (mm): 70 W* 32mm
Max. Cable weight: 22kg
Weight of Trolley: 0.55kg

C32MT-70 - Middle trolley

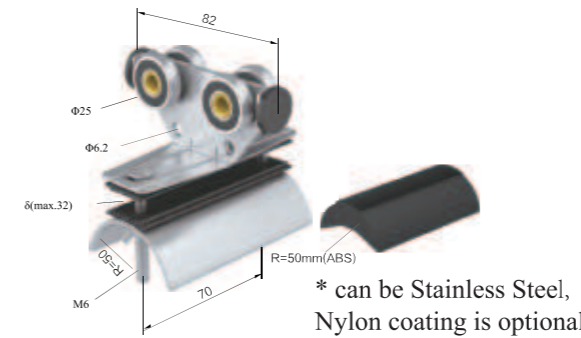

* can be Stainless Steel,
Nylon coating is optional

Technical Feature

Wheels: Ball bearing
Max Travel Speed: 120m/min
Material: Galvanized Steel + ABS
Temperature: $-30^\circ\text{C} \sim +100^\circ\text{C}$
Max. Cable (mm): 70 W* 32mm
Max. Cable weight: 22kg
Weight of Trolley: 0.32kg

C32ET- End trolley

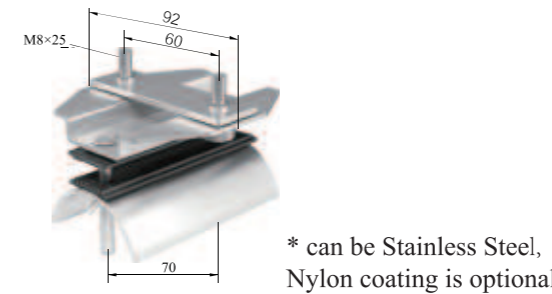

* can be Stainless Steel,
Nylon coating is optional

Technical Feature

Max Travel Speed: 120m/min
Material: Galvanized Steel + ABS
Temperature: $-30^\circ\text{C} \sim +100^\circ\text{C}$
Max. Cable (mm): 70 W* 32mm
Max. Cable weight: 25kg
Weight of Trolley: 0.31kg

C-track Festoon Accessories - C32 Trolley for Flat Cable
C32MT-60 Middle trolley

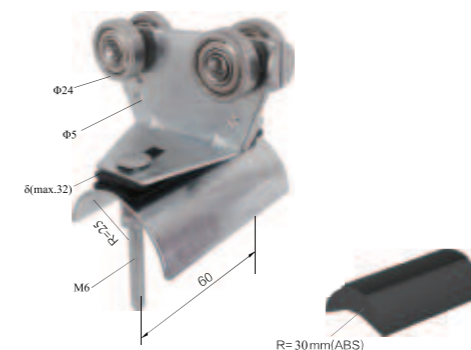

Technical Feature

Wheels: Bearing
Max Travel Speed: 120m/min
Material: Galvanized Steel + ABS
Temperature: $-30^\circ\text{C} \sim +100^\circ\text{C}$
Max. Cable (mm): 60 W* 32mm
Max. Cable weight: 20kg
Weight of Trolley: 0.32kg

C-track Festoon Accessories - C32 Plastic Middle Trolley
C32PP-70 / C32RPP-30

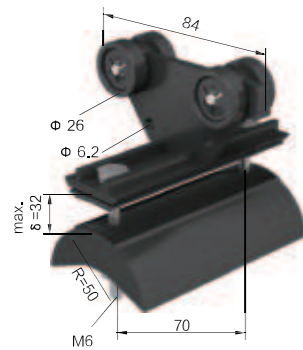

Technical Feature

Wheels: Nylon
Max Travel Speed: 120m/min
Material: --ABS
Temperature: -30°C ~ + 80°C
Max. Cable (mm): 70 W* 32mm
Max. Cable weight: 8kg
Weight of Trolley: 0.14kg

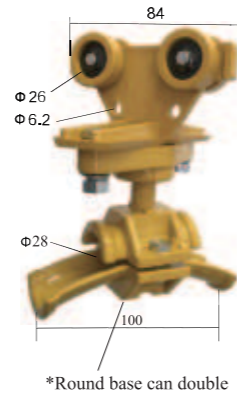

Technical Feature

Wheels: Nylon
Max Travel Speed: 120m/min
Material: Galvanized Steel + ABS
Temperature: -30°C ~ + 80°C
Max. Cable (mm): ϕ 28mm
Max. Cable weight: 8kg
Weight of Trolley: 0.15kg

C-track Festoon accessories - C32 Plastic Middle Trolley
C32RMT

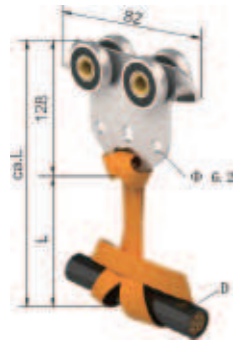

Technical Feature

Wheels: Ball bearing
Max Travel Speed: 120m/min
Material: Galvanized Steel + Nylon
Temperature: -30°C ~ + 100°C
Max. Cable (mm): ϕ 50mm / ϕ 80mm / ϕ 160mm
Max. Cable weight: 22kg
Weight of Trolley: 0.29kg

C-track Festoon Accessories - C32 Hanger
C32HG-1/ C32HG-2/ C32HG-5

C32HG-1/ C32HG-2 for C-track support bracket

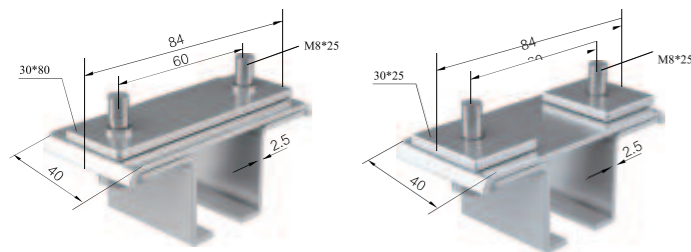

C32HG-5 for Angle steel support bracket

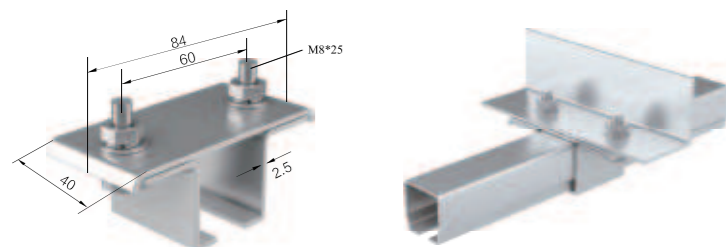

Type	Weight (kg)	Material
C32HG-1	0.22	Galvanized Steel
C32HG-2	0.22	Steel
C32HG-5	0.20	Steel

C-track Festoon Accessories - C32 Joints
C32JS-2 / C32JS-1

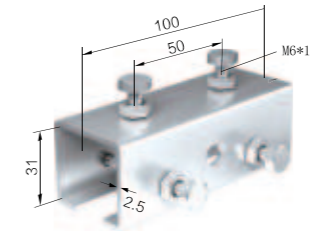
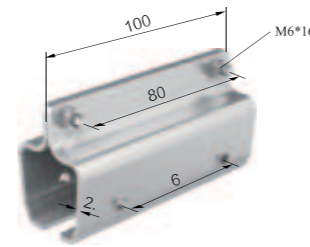

Type	Weight (kg)	Material
C32JS-2	0.27	Galvanized Steel
C32JS-1	0.3	Steel

C-track Festoon Accessories - C32 End Cap
C32EC



Type	Weight (kg)	Material
C32EC	0.005	Plastic

C-track Festoon Accessories - C32 End Stop
C32ED

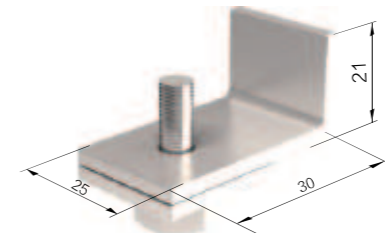

Type	Weight (kg)	Material
C32ED	0.05	Galvanized Steel

*C32ED used for C32/C40 track



C-track Festoon accessories - C32 Cable Clip
C32CP

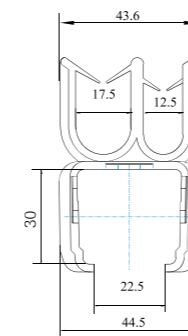

Type	Weight (kg)	Material
C32CP	0.02	Plastic

C-track Festoon Accessories - C32 Pendant Trolley for Flat Cable
C32PT

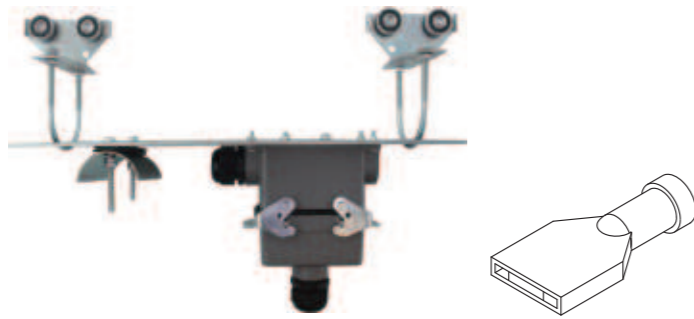

Type	Weight (kg)	Material
C32PT	2.5	Galvanized Steel

Can Customized with Flat Cable Gland

C-track Festoon Accessories - C40 Trolleys
C40TT / C40MT / C40RMT

C40TT - Towing trolley

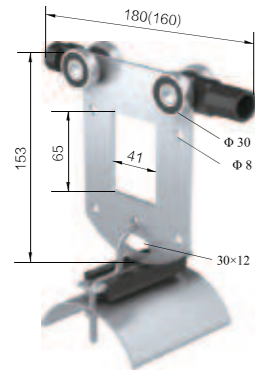

Technical Feature

Wheels: Ball bearing
 Max Travel Speed: 160m/min
 Material: Galvanized Steel + ABS
 Temperature: -30°C ~ +100°C
 Max. Cable (mm): 75 W*32mm
 Max. Cable weight: 35kg
 Weight of Trolley: 0.65kg

C40MT - Middle trolley

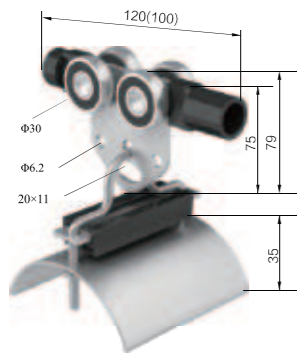

Technical Feature

Wheels: Ball bearing
 Max Travel Speed: 160m/min
 Material: Galvanized Steel + ABS
 Temperature: -30°C ~ +100°C
 Max. Cable (mm): 75 W*32mm
 Max. Cable weight: 30kg
 Weight of Trolley: 0.52kg

C40RMT - Plastic middle trolley

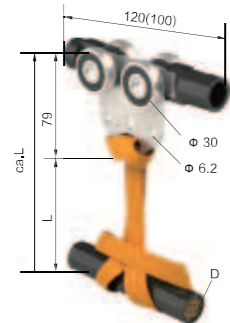

Technical Feature

Wheels: Ball bearing
 Max Travel Speed: 100m/min
 Material: Galvanized Steel + Nylon
 Temperature: -30°C ~ +100°C
 Max. Cable (mm): $\phi 50\text{mm}$ / $\phi 80\text{mm}$ / $\phi 160\text{mm}$
 Max. Cable weight: 28kg
 Weight of Trolley: 0.33kg

C-track Festoon Accessories - C40 Hanger
C40HG-1 / C40HG-2 / C40HG-5

C40HG-1 and C40HG-2 for C-track support bracket

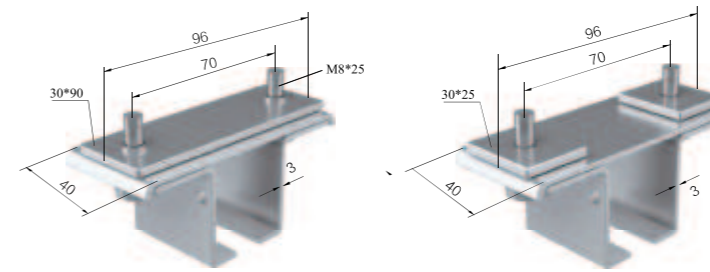

C40HG-5 for Angle steel support bracket

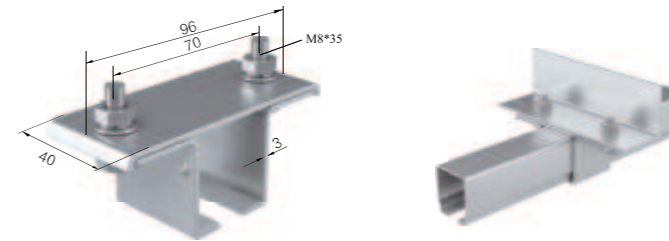

Type	Weight (kg)	Material
C40HG-1	0.30	Galvanized Steel
C40HG-2	0.30	
C40HG-5	0.22	

C-track Festoon Accessories - C40 Joints
C40JS-2

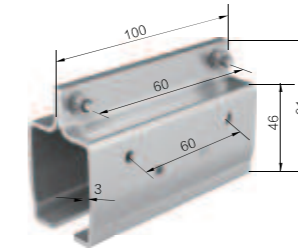

Type	Weight (kg)	Material
C40JS-2	0.32	Galvanized Steel

C-track Festoon Accessories - C40 End Cap
C40EC

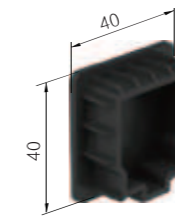

Type	Weight (kg)	Material
C40EC	0.01	Plastic

C-track Festoon Accessories - C40 Pendant Trolley for Flat Cable
C40PT



Type	Weight (kg)	Material
C40PT	2.7	Galvanized Steel

Can Customized with Flat Cable Gland

C-track Festoon Accessories - C63 Trolleys for Flat Cable
C63TT / C63MT/ C63ET

C63TT- Towing trolley

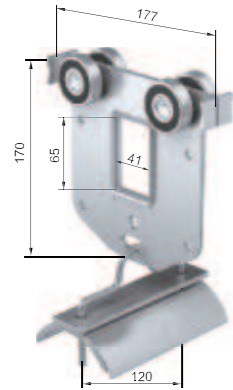

Technical Feature

Wheels: Ball bearing
Max Travel Speed: 160m/min
Material: Galvanized Steel
Temperature: -30°C ~ +100°C
Max. Cable (mm): 120 W*40mm
Max. Cable weight: 65kg
Weight of Trolley: 2.3kg

C63MT - Middle trolley

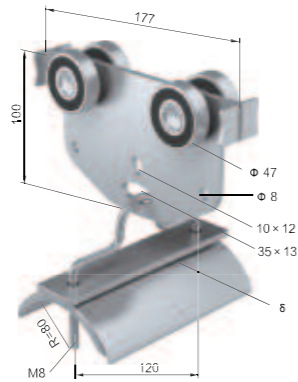

Technical Feature

Wheels: Ball bearing
Max Travel Speed: 160m/min
Material: Galvanized Steel
Temperature: -30°C ~ +100°C
Max. Cable (mm): 120 W*40mm
Max. Cable weight: 65kg
Weight of Trolley: 1.95kg

C63ET - End trolley

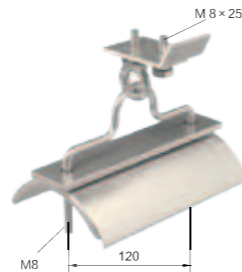

Technical Feature

Max Travel Speed: 160m/min
Material: Galvanized Steel
Temperature: -30°C ~ +100°C
Max. Cable (mm): 120 W*40mm
Max. Cable weight: 65kg
Weight of Trolley: 1.15kg

C-track Festoon Accessories - C63 Hanger
C63HG

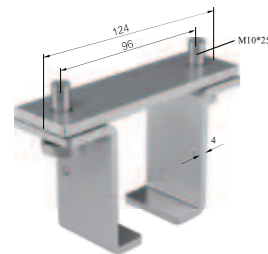

Type	Weight (kg)	Material
C63HG	0.45	Galvanized Steel

C-track Festoon Accessories - Joints
C63JS

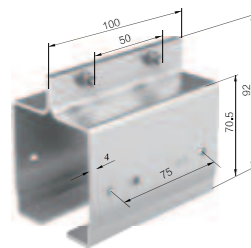

Type	Weight (kg)	Material
C63JS	0.72	Galvanized Steel

C-track Festoon Accessories - End Stop
C63ED

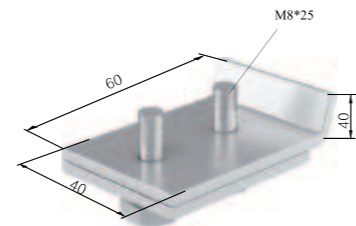

Type	Weight (kg)	Material
C63ED	0.72	Galvanized Steel

C-track Festoon Accessories - C40 Support Attachment
C40SA-1 /C40SA-2

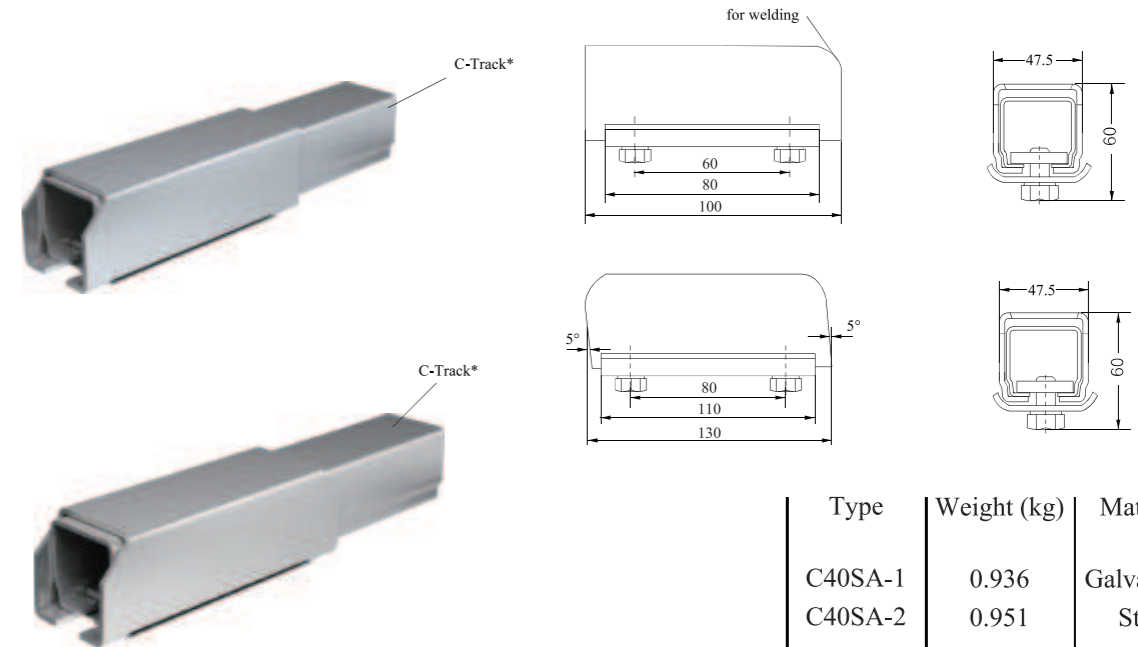

Type	Weight (kg)	Material
C40SA-1	0.936	Galvanized Steel
C40SA-2	0.951	Steel

C-track Festoon Accessories - C-track Claw
C32TC-1/ C40TC-1

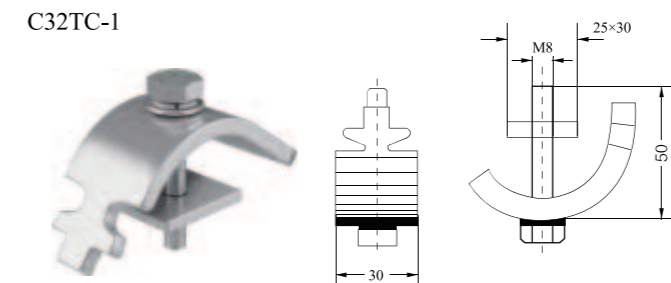

Be used for Standard Bracket

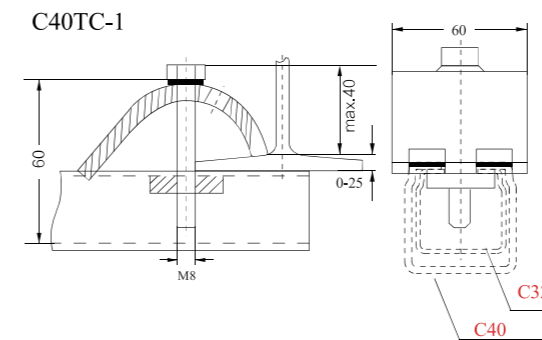

Be used for Heavy duty Bracket

Type	Weight (kg)	Material
C32TC-1	0.202	Galvanized Steel
C40TC-1	0.281	Steel

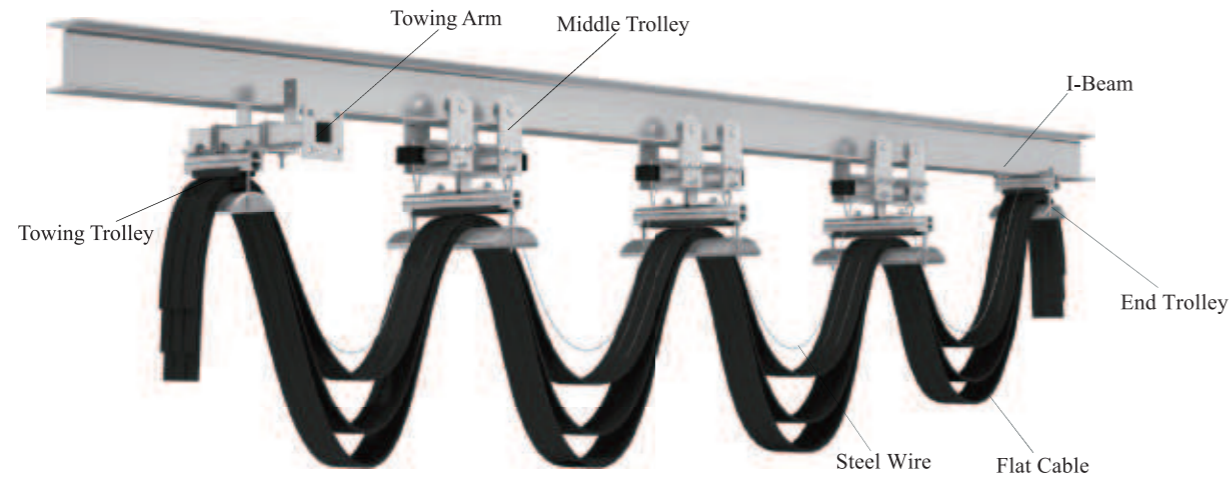

I-Beam Trolley
N35MTA / N35TT / N35ET series

N35MTA - Middle trolley

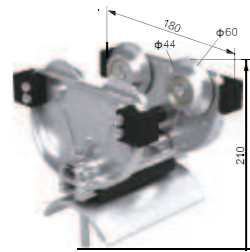

N35TT - Towing trolley

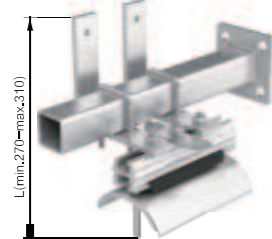

N35ET - End trolley

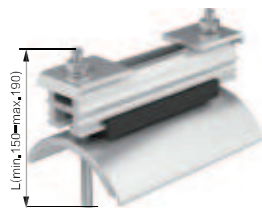

Type	Max.cable load	Dia. of Cable(mm)	Weight (kg)
N35MTA-120	max.35kg/trolley	max.120 W × 50δ	2.20
N35MTA-150	max.40kg/trolley	max.150 W × 60δ	2.40
N35TT-120	max.60kg/trolley	max.120 W × 50δ	1.25
N35TT-150	max.70kg/trolley	max.150 W × 50δ	1.45
N35ET-120	max.60kg/trolley	max.120 W × 50δ	2.10
N35ET-150	max.70kg/trolley	max.150 W × 50δ	2.30

I-Beam Trolley - for Round Cable
N15RMT

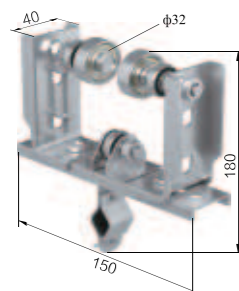

Type	Max.cable load	Dia. of Cable(mm)	Weight (kg)
N15RMT	max.5kg/trolley	D= φ 15mm	0.64

I-Beam Trolley
N75MT-1 series / N75MT-2series / N75MT-1 series

N75-1 - Middle trolley

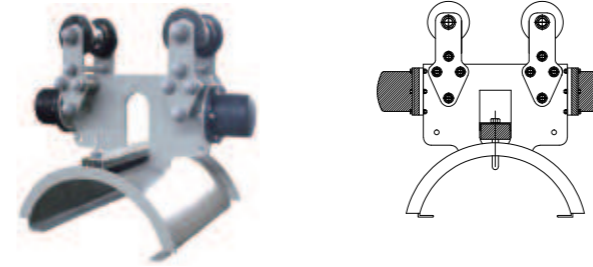

Technical Feature

Wheels: Ball bearing
Max Travel Speed: 160m/min
Material: Galvanized Steel + ABS
Temperature: -30°C ~ +100°C
Max. Cable weight: 200kg

N75-2 - Middle trolley

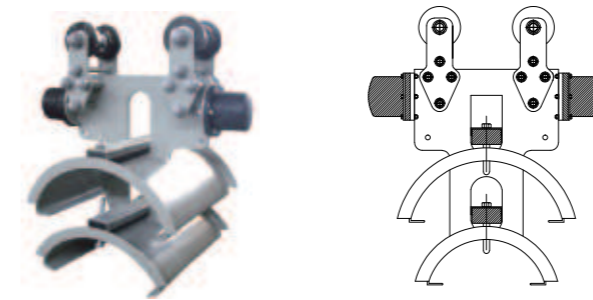

Technical Feature

Wheels: Ball bearing
Max Travel Speed: 160m/min
Material: Galvanized Steel + ABS
Temperature: -30°C ~ +100°C
Max. Cable weight: 200kg

N75-3 - Middle trolley

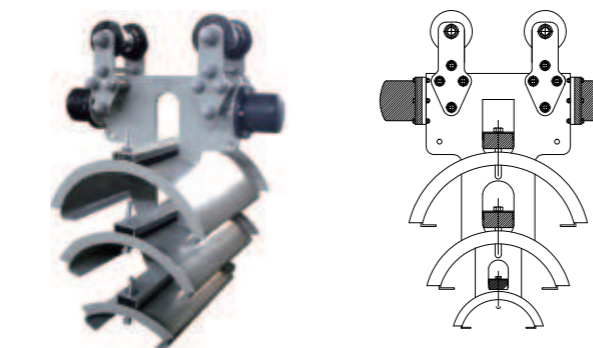

Technical Feature

Wheels: Ball bearing
Max Travel Speed: 160m/min
Material: Galvanized Steel + ABS
Temperature: -30°C ~ +100°C
Max. Cable weight: 200kg

Wire Rope Festoon Accessories - for Round Cable
ST-12/14 & ST-14/16

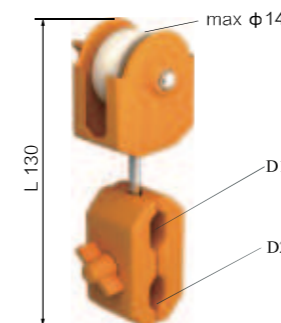

Technical Feature

Wheels: Plastic
Max Travel Speed: 100m/min
Material: Plastic
Temperature: -30°C ~ +80°C

Type	Max.cable load	Dia. of Cable(mm)	Weight (kg)
ST-12/14	max.6kg/trolley	max.D1/D2= φ12mm/12mm	0.08
ST-14/16	max.7kg/trolley	max.D1/D2= φ12mm/12mm	0.09